

LOCATION: NE 152nd Ave -- NE Fourth Plain Rd
CITY/STATE: Vancouver, WA

QC JOB #: 14655108
DATE: Wed, Mar 21 2018

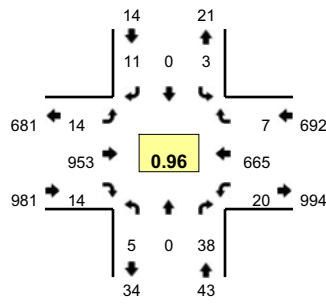

Peak-Hour: 4:00 PM -- 5:00 PM
Peak 15-Min: 4:10 PM -- 4:25 PM

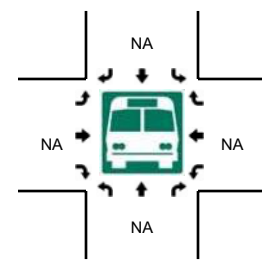
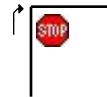
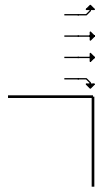
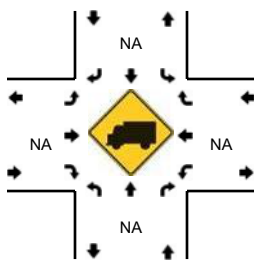
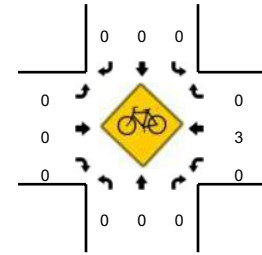
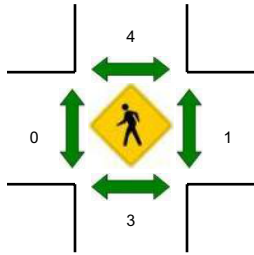
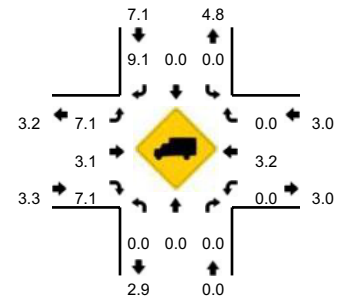

5-Min Count Period Beginning At	NE 152nd Ave (Northbound)				NE 152nd Ave (Southbound)				NE Fourth Plain Rd (Eastbound)				NE Fourth Plain Rd (Westbound)				Total	Hourly Totals
	Left	Thru	Right	U	Left	Thru	Right	U	Left	Thru	Right	U	Left	Thru	Right	U		
4:00 PM	1	0	5	0	0	0	1	0	0	84	2	0	3	47	1	0	144	
4:05 PM	0	0	4	0	0	0	1	0	1	75	1	0	2	53	0	0	137	
4:10 PM	0	0	1	0	0	0	1	0	2	83	0	0	1	58	2	0	148	
4:15 PM	0	0	3	0	0	0	2	0	1	91	1	0	1	57	0	0	156	
4:20 PM	0	0	2	0	2	0	1	0	0	64	1	0	1	77	0	0	148	
4:25 PM	0	0	5	0	0	0	0	0	1	77	0	0	1	63	0	0	147	
4:30 PM	1	0	2	0	0	0	1	0	3	81	3	0	2	36	0	0	129	
4:35 PM	1	0	1	0	0	0	2	0	1	88	1	0	1	57	0	0	152	
4:40 PM	2	0	6	0	0	0	0	0	1	72	0	0	3	51	0	0	135	
4:45 PM	0	0	3	0	1	0	2	0	1	79	1	0	0	63	3	0	153	
4:50 PM	0	0	4	0	0	0	0	0	2	87	2	0	1	46	0	0	142	
4:55 PM	0	0	2	0	0	0	0	0	1	72	2	0	4	57	1	0	139	1730
5:00 PM	0	0	5	0	0	0	1	0	0	62	1	0	1	46	0	0	116	1702
5:05 PM	0	0	2	0	0	0	0	0	1	85	4	0	2	51	1	0	146	1711
5:10 PM	0	0	4	0	0	0	0	0	2	85	2	0	0	68	2	0	163	1726
5:15 PM	0	0	0	0	1	0	0	0	2	73	2	0	5	60	1	0	144	1714
5:20 PM	0	0	2	0	0	0	1	0	1	69	1	0	1	54	0	0	129	1695
5:25 PM	0	0	8	0	0	0	0	0	2	92	1	0	2	54	0	0	159	1707
5:30 PM	0	0	4	0	0	0	1	0	1	79	1	0	3	53	1	0	143	1721
5:35 PM	0	0	2	0	0	0	1	0	0	83	0	0	1	52	1	0	140	1709
5:40 PM	0	0	2	0	0	0	0	0	0	78	0	0	1	60	0	0	141	1715
5:45 PM	0	0	0	0	1	0	0	0	1	81	1	0	0	52	1	0	137	1699
5:50 PM	0	0	2	0	0	0	1	0	1	89	1	0	1	60	1	0	156	1713
5:55 PM	1	0	4	0	0	0	1	0	0	71	3	0	0	61	3	0	144	1718
Peak 15-Min Flowrates	Northbound				Southbound				Eastbound				Westbound				Total	
	Left	Thru	Right	U	Left	Thru	Right	U	Left	Thru	Right	U	Left	Thru	Right	U		
All Vehicles	0	0	24	0	8	0	16	0	12	952	8	0	12	768	8	0	1808	
Heavy Trucks	0	0	0	0	0	0	0	0	0	32	0	0	0	32	0	0	64	
Pedestrians			4			12				0				0			16	
Bicycles	0	0	0	0	0	0	0	0	0	0	0	0	0	0	0	0	0	
Railroad																		
Stopped Buses																		

Comments: