

LOCATION: NE 152nd Ave -- NE Fourth Plain Rd
CITY/STATE: Vancouver, WA

QC JOB #: 14655107
DATE: Wed, Mar 21 2018

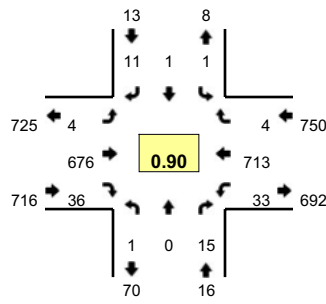

Peak-Hour: 7:25 AM -- 8:25 AM
Peak 15-Min: 7:40 AM -- 7:55 AM

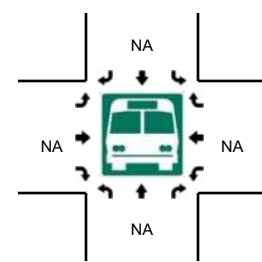
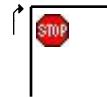
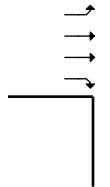
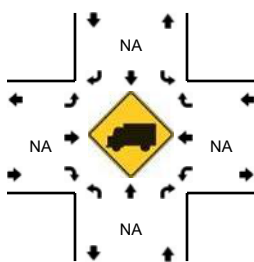
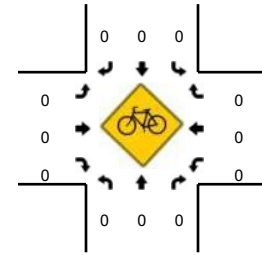
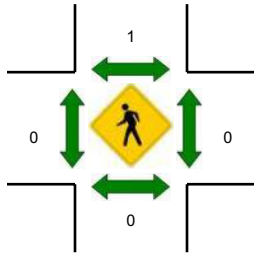
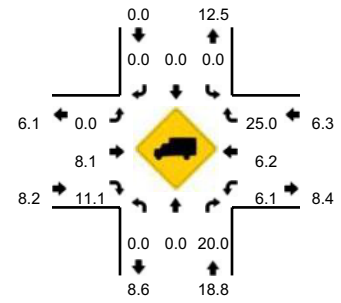

5-Min Count Period Beginning At	NE 152nd Ave (Northbound)				NE 152nd Ave (Southbound)				NE Fourth Plain Rd (Eastbound)				NE Fourth Plain Rd (Westbound)				Total	Hourly Totals
	Left	Thru	Right	U	Left	Thru	Right	U	Left	Thru	Right	U	Left	Thru	Right	U		
7:00 AM	0	0	1	0	0	0	0	0	0	25	1	1	2	36	1	0	67	
7:05 AM	0	0	1	0	1	0	1	0	0	38	3	0	3	38	0	0	85	
7:10 AM	0	0	5	0	0	0	0	0	0	41	0	0	4	42	0	0	92	
7:15 AM	0	0	0	0	0	0	1	0	1	48	2	0	2	52	1	0	107	
7:20 AM	0	0	0	0	0	0	5	0	0	42	1	0	1	51	0	0	100	
7:25 AM	0	0	1	0	0	0	3	0	2	80	3	0	2	51	0	0	142	
7:30 AM	0	0	0	0	0	0	2	0	0	49	0	0	1	59	1	0	112	
7:35 AM	0	0	0	0	0	0	0	0	1	63	3	0	1	53	0	0	121	
7:40 AM	0	0	1	0	0	0	0	0	0	62	3	0	2	65	0	0	133	
7:45 AM	0	0	1	0	0	0	3	0	1	78	2	0	2	56	1	0	144	
7:50 AM	0	0	3	0	0	0	0	0	0	62	9	0	3	60	0	0	137	
7:55 AM	0	0	3	0	0	0	0	0	0	55	7	0	5	61	1	0	132	1372
8:00 AM	0	0	3	0	0	0	0	0	0	40	1	0	7	57	0	0	108	1413
8:05 AM	0	0	0	0	1	0	1	0	0	51	3	0	2	71	0	0	129	1457
8:10 AM	0	0	2	0	0	1	1	0	0	43	3	0	2	55	1	0	108	1473
8:15 AM	1	0	0	0	0	0	1	0	0	50	1	0	3	66	0	0	122	1488
8:20 AM	0	0	1	0	0	0	0	0	0	43	1	0	3	59	0	0	107	1495
8:25 AM	0	0	1	0	1	0	5	0	0	51	2	0	4	51	0	0	115	1468
8:30 AM	0	0	5	0	0	0	0	0	1	48	1	0	0	53	0	0	108	1464
8:35 AM	0	0	0	0	0	0	0	0	0	51	1	0	1	52	0	0	105	1448
8:40 AM	0	0	4	0	0	0	0	0	0	55	2	0	5	59	0	0	125	1440
8:45 AM	0	0	2	0	0	0	0	0	0	53	2	0	3	51	0	0	111	1407
8:50 AM	0	0	2	0	0	0	1	0	1	42	1	0	2	48	0	0	97	1367
8:55 AM	1	0	0	0	0	1	0	0	0	51	3	0	5	41	0	0	102	1337
Peak 15-Min Flowrates	Northbound				Southbound				Eastbound				Westbound				Total	
	Left	Thru	Right	U	Left	Thru	Right	U	Left	Thru	Right	U	Left	Thru	Right	U		
All Vehicles	0	0	20	0	0	0	12	0	4	808	56	0	28	724	4	0	1656	
Heavy Trucks	0	0	4		0	0	0		0	28	0		4	44	0		80	
Pedestrians	0				0				0	0	0		0	0	0		0	
Bicycles	0	0	0		0	0	0		0	0	0		0	0	0		0	
Railroad																		
Stopped Buses																		

Comments: