

**LOCATION:** NE 20th Ave -- NE 139th St  
**CITY/STATE:** Vancouver, WA

**QC JOB #:** 10837010  
**DATE:** Tue, Oct 23 2012

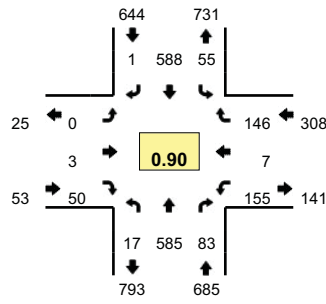

**Peak-Hour: 4:35 PM -- 5:35 PM**  
**Peak 15-Min: 5:05 PM -- 5:20 PM**

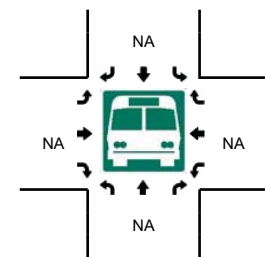
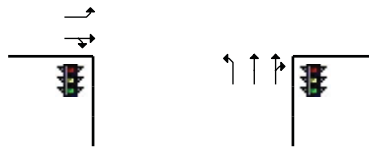
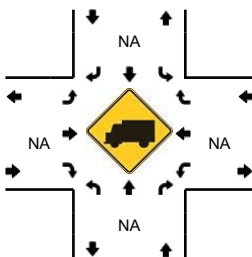
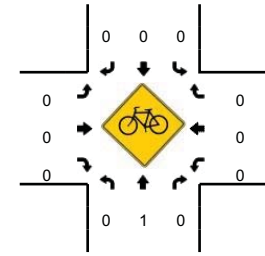
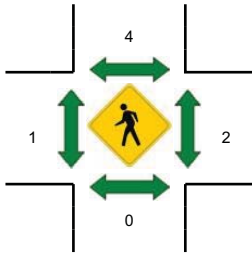
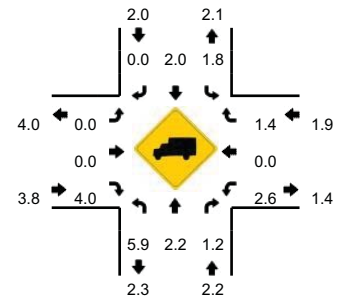

5-Min Count Period Beginning At	NE 20th Ave (Northbound)				NE 20th Ave (Southbound)				NE 139th St (Eastbound)				NE 139th St (Westbound)				Total	Hourly Totals
	Left	Thru	Right	U	Left	Thru	Right	U	Left	Thru	Right	U	Left	Thru	Right	U		
4:00 PM	0	61	9	0	5	40	0	0	0	0	2	0	15	1	12	0	145	
4:05 PM	1	57	3	0	0	50	0	0	0	0	3	0	20	0	4	0	138	
4:10 PM	0	33	10	0	6	41	0	0	1	0	3	0	9	1	4	0	108	
4:15 PM	1	43	5	0	3	39	0	0	0	0	2	0	15	1	10	0	119	
4:20 PM	1	64	10	0	3	29	0	0	0	0	1	0	12	0	9	0	129	
4:25 PM	1	54	13	0	3	50	0	0	0	1	1	0	18	0	12	0	153	
4:30 PM	1	35	8	0	6	44	0	0	0	0	2	0	23	0	3	0	122	
4:35 PM	2	38	19	0	3	45	0	0	0	0	2	0	8	1	11	0	129	
4:40 PM	0	51	9	0	5	40	0	0	0	0	0	0	15	0	15	0	135	
4:45 PM	1	60	4	0	6	48	0	0	0	0	7	0	6	0	11	0	143	
4:50 PM	1	41	8	0	1	54	0	0	0	0	2	0	15	1	10	0	133	
4:55 PM	0	41	3	0	5	38	0	0	0	0	4	0	11	0	16	0	118	1572
5:00 PM	1	33	8	0	5	58	0	0	0	0	3	0	12	2	8	0	130	1557
5:05 PM	2	67	3	0	4	60	0	0	0	0	4	0	14	0	11	0	165	1584
5:10 PM	2	45	9	0	3	60	1	0	0	1	3	0	14	2	11	0	151	1627
5:15 PM	1	53	6	0	7	54	0	0	0	0	8	0	12	0	10	0	151	1659
5:20 PM	5	52	6	0	5	38	0	0	0	2	6	0	10	0	16	0	140	1670
5:25 PM	1	50	6	0	8	51	0	0	0	0	8	0	16	1	15	0	156	1673
5:30 PM	1	54	2	0	3	42	0	0	0	0	3	0	22	0	12	0	139	1690
5:35 PM	1	44	2	0	4	40	0	0	0	1	3	0	13	0	12	0	120	1681
5:40 PM	0	51	5	0	0	38	0	0	0	0	2	0	10	0	3	0	109	1655
5:45 PM	2	46	5	0	9	45	0	0	0	0	7	0	7	0	8	0	129	1641
5:50 PM	1	51	6	0	3	36	0	0	0	0	3	0	9	1	7	0	117	1625
5:55 PM	1	45	5	0	1	37	0	0	0	0	1	0	17	0	7	0	114	1621
Peak 15-Min Flowrates	Northbound				Southbound				Eastbound				Westbound				Total	
	Left	Thru	Right	U	Left	Thru	Right	U	Left	Thru	Right	U	Left	Thru	Right	U		
All Vehicles	20	660	72	0	56	696	4	0	0	4	60	0	160	8	128	0	1868	
Heavy Trucks	0	8	0		0	12	0		0	0	0		4	0	4		28	
Pedestrians		0				4				4				8			16	
Bicycles	0	0	0		0	0	0		0	0	0		0	0	0		0	
Railroad																		
Stopped Buses																		

Comments: