

LOCATION: NE 137th Ave -- NE 76th St
CITY/STATE: Vancouver, WA

QC JOB #: 14655113
DATE: Wed, Mar 21 2018

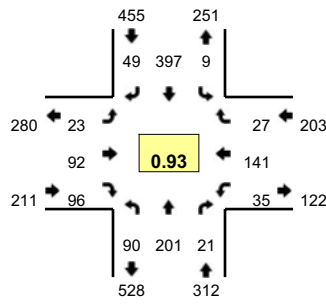

Peak-Hour: 7:20 AM -- 8:20 AM
Peak 15-Min: 7:30 AM -- 7:45 AM

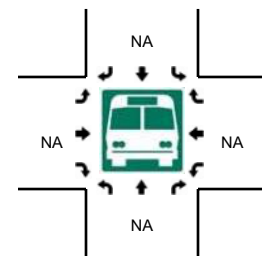
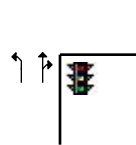
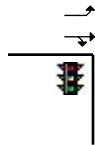
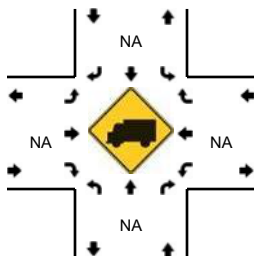
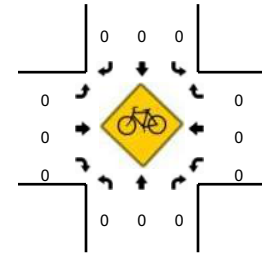
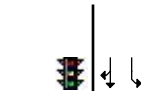
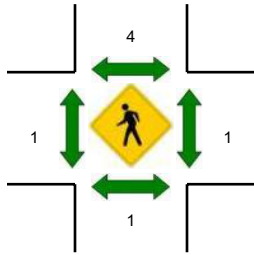
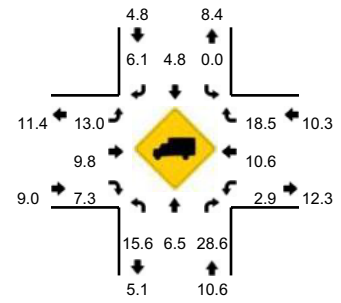

5-Min Count Period Beginning At	NE 137th Ave (Northbound)				NE 137th Ave (Southbound)				NE 76th St (Eastbound)				NE 76th St (Westbound)				Total	Hourly Totals
	Left	Thru	Right	U	Left	Thru	Right	U	Left	Thru	Right	U	Left	Thru	Right	U		
7:00 AM	4	9	0	0	0	25	4	0	1	4	3	0	8	12	0	0	70	
7:05 AM	5	7	1	0	0	22	4	0	0	10	5	0	3	8	1	0	66	
7:10 AM	9	13	0	0	0	20	3	0	2	9	12	0	1	10	1	0	80	
7:15 AM	3	14	3	0	1	40	6	0	2	4	16	0	3	5	2	0	99	
7:20 AM	10	15	2	0	0	33	5	0	2	10	10	0	5	18	1	0	111	
7:25 AM	7	5	3	0	0	19	0	0	3	9	13	0	4	5	3	0	71	
7:30 AM	5	24	0	0	2	40	5	0	1	6	8	0	2	8	1	0	102	
7:35 AM	1	26	0	0	1	34	2	0	2	9	8	0	7	17	6	0	113	
7:40 AM	3	18	1	0	1	41	6	0	1	9	5	0	2	12	3	0	102	
7:45 AM	5	13	2	0	0	33	6	0	3	8	15	0	2	2	3	0	92	
7:50 AM	7	24	2	0	1	32	4	0	1	3	7	0	2	9	3	0	95	
7:55 AM	5	12	3	0	0	37	3	0	3	5	3	0	3	17	3	0	94	1095
8:00 AM	5	21	2	0	1	35	3	0	3	8	13	0	0	7	1	0	99	1124
8:05 AM	12	13	2	0	1	35	3	0	3	12	3	0	3	12	2	0	101	1159
8:10 AM	13	13	3	0	1	29	4	0	1	4	5	0	3	19	0	0	95	1174
8:15 AM	17	17	1	0	1	29	8	0	0	9	6	0	2	15	1	0	106	1181
8:20 AM	9	15	1	0	0	24	6	0	2	9	12	0	2	18	1	0	99	1169
8:25 AM	9	15	1	0	0	20	10	0	4	16	13	0	4	20	2	0	114	1212
8:30 AM	7	13	0	0	1	24	9	0	3	14	13	0	4	21	3	0	112	1222
8:35 AM	10	16	2	0	0	31	5	0	6	10	12	0	3	14	3	0	112	1221
8:40 AM	12	22	1	0	1	23	7	0	4	18	16	0	2	12	2	0	120	1239
8:45 AM	9	11	5	0	0	22	7	0	6	6	10	0	6	11	2	0	95	1242
8:50 AM	4	8	5	0	4	36	4	0	2	10	14	0	1	11	2	0	101	1248
8:55 AM	9	16	2	0	1	21	6	0	3	9	24	0	4	13	2	0	110	1264
Peak 15-Min Flowrates	Northbound				Southbound				Eastbound				Westbound				Total	
	Left	Thru	Right	U	Left	Thru	Right	U	Left	Thru	Right	U	Left	Thru	Right	U		
All Vehicles	36	272	4	0	16	460	52	0	16	96	84	0	44	148	40	0	1268	
Heavy Trucks	4	20	0		0	24	4		4	8	4		4	8	12		92	
Pedestrians		4				8				4				4			20	
Bicycles	0	0	0		0	0	0		0	0	0		0	0	0		0	
Railroad																		
Stopped Buses																		

Comments: