

**LOCATION:** NE 137th Ave -- NE Fourth Plain Rd  
**CITY/STATE:** Vancouver, WA

**QC JOB #:** 14655101  
**DATE:** Wed, Mar 21 2018

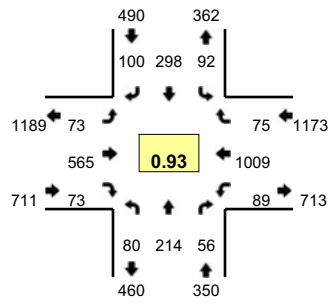

**Peak-Hour: 7:20 AM -- 8:20 AM**  
**Peak 15-Min: 7:35 AM -- 7:50 AM**

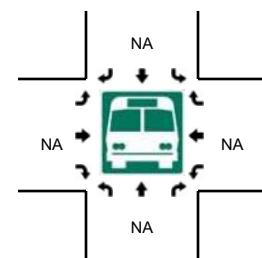
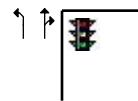
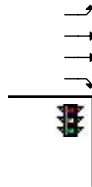
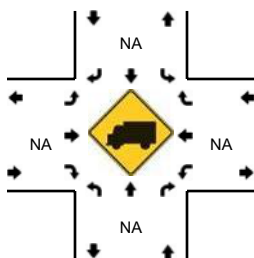
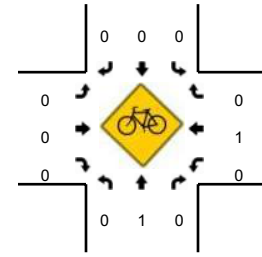
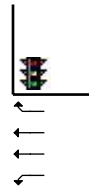
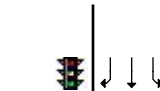
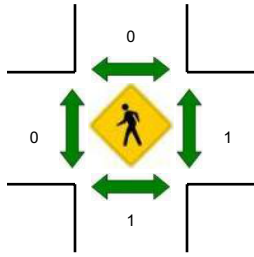
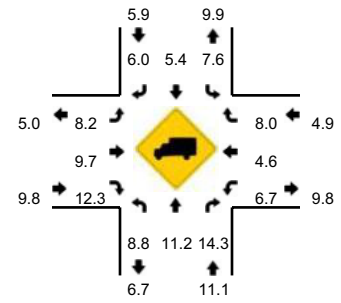

5-Min Count Period Beginning At	NE 137th Ave (Northbound)				NE 137th Ave (Southbound)				NE Fourth Plain Rd (Eastbound)				NE Fourth Plain Rd (Westbound)				Total	Hourly Totals
	Left	Thru	Right	U	Left	Thru	Right	U	Left	Thru	Right	U	Left	Thru	Right	U		
7:00 AM	8	9	4	0	6	10	16	0	2	35	1	0	3	69	4	0	167	
7:05 AM	3	19	1	0	3	22	7	0	1	26	3	0	6	75	5	0	171	
7:10 AM	8	12	1	0	6	13	5	0	5	44	2	0	4	64	7	0	171	
7:15 AM	7	17	2	0	6	32	10	0	4	35	7	0	5	75	0	0	200	
7:20 AM	7	16	3	0	9	24	11	0	3	44	6	0	7	94	3	0	227	
7:25 AM	7	20	5	0	12	30	6	0	5	44	3	0	9	90	3	0	234	
7:30 AM	9	10	5	0	7	18	10	0	9	50	7	0	4	94	6	0	229	
7:35 AM	7	23	5	0	7	40	4	0	7	45	2	0	8	90	7	0	245	
7:40 AM	10	13	5	0	10	23	13	0	10	52	8	0	10	82	0	0	236	
7:45 AM	11	23	7	0	11	26	7	0	5	50	7	0	14	85	4	0	250	
7:50 AM	2	16	5	0	8	20	9	0	4	65	9	0	7	88	8	0	241	
7:55 AM	3	17	7	0	5	20	3	0	6	49	7	0	5	65	11	0	198	2569
8:00 AM	5	20	3	0	10	24	11	0	6	37	7	0	5	69	6	0	203	2605
8:05 AM	5	22	5	0	3	28	9	0	2	41	4	0	5	77	5	0	206	2640
8:10 AM	8	15	3	0	6	26	10	0	9	46	9	0	7	84	11	0	234	2703
8:15 AM	6	19	3	0	4	19	7	0	7	42	4	0	8	91	11	0	221	2724
8:20 AM	11	20	4	0	7	17	6	0	6	38	3	0	6	68	1	0	187	2684
8:25 AM	4	16	7	0	4	27	8	0	5	37	2	0	7	106	11	0	234	2684
8:30 AM	10	13	4	0	7	22	7	0	5	60	3	0	2	77	4	0	214	2669
8:35 AM	7	32	2	0	10	22	10	0	5	35	3	0	2	86	5	0	219	2643
8:40 AM	8	16	5	0	13	15	5	0	8	53	5	0	8	83	6	0	225	2632
8:45 AM	5	15	4	0	12	22	8	0	5	36	2	0	6	79	7	0	201	2583
8:50 AM	11	14	5	0	10	19	13	0	6	27	8	0	6	76	4	0	199	2541
8:55 AM	5	17	8	0	12	24	8	0	8	50	2	0	1	50	8	0	193	2536
Peak 15-Min Flowrates	Northbound				Southbound				Eastbound				Westbound				Total	
	Left	Thru	Right	U	Left	Thru	Right	U	Left	Thru	Right	U	Left	Thru	Right	U		
All Vehicles	112	236	68	0	112	356	96	0	88	588	68	0	128	1028	44	0	2924	
Heavy Trucks	4	16	8		4	4	4		4	44	4		8	32	4		136	
Pedestrians		0				0				0				0			0	
Bicycles	0	0	0		0	0	0		0	0	0		0	0	0		0	
Railroad																		
Stopped Buses																		

Comments: